

General :

Using the 2530.03.25P output terminal it is possible to make any electrical signals not used by valves available on a 25 sub-D female connector at the right end of the manifold.
It is possible to then join a multi-core cable to link to the next manifold, or connect directly to one or two I/O modules.
The I/O modules can accept input or output signals, depending upon what is connected.

Please note: If the manifold is connected by a multi-core connection, each connection can be used as either an input or an output, while if the manifold is connected to a serial node the connections can only be used as an output.

It is possible to connect the manifold to up to two I/O modules.

Each I/O module includes 8 diagnostic LEDs which indicate the presence of an Input / Output signal for each connector.

Please note: For an LED to function, a signal of at least +15VDC must be present on pin 4 of the connector. If this signal is lower, the LED will not light, this does not compromise the normal Input / Output function of the unit.

Ordering code

2530.08F

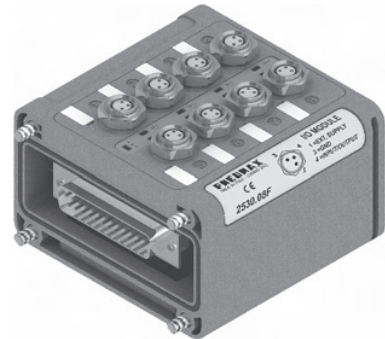

Overall dimensions and I/O layout :

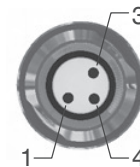
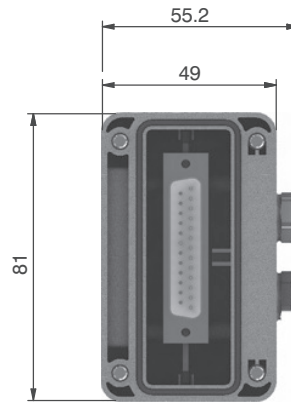
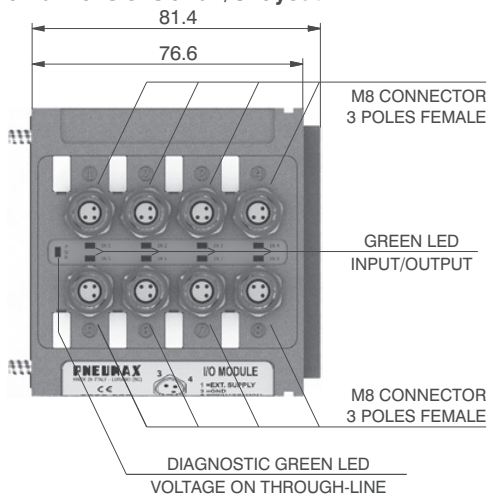

PIN	DESCRIPTION
1	+24 VDC
4	INPUT/OUTPUT
3	GND

Input features:

Each connection can accept either two wire (switches, magnetic switches, pressure switches, etc.) or three wire connections (photocells, electronic end of stroke sensors, etc.) If +24VDC is required on at Pin 1 of each connector, it is possible to provide this via the through-line pin of the multi-pole connector.

I.E :

Pin 25 of the 25 pin multi-pole connector (code 2530.02.25P or 2530.12.25P)

Pin 36-37 of the 37 pin multi-pole connector (code 2530.02.37P or 2530.12.37P)

Output features:



Attention: The output connections are not protected against short-circuit. Please pay attention when wiring (avoid Pin 4 being connected to Pin 3 or Pin 1).

General characteristics	Model	2530.08F
	Case	Reinforced technopolymer
	I/O Connector	M8 connector 3 poles female (IEC 60947-5-2)
	PIN1 voltage (connector used as Input)	By the user
	PIN 4 voltage diagnosis	Green LED
	Node consumption (Outlets excluded)	7mA per each LED with 24 VDC signal
	Outlets voltage	+23,3 VDC (serial) /by the user (multipolar)
	Input voltage	Depend by the using
	Maximum outlet current	100 mA (serial) / 400 mA (multipolar)
	Maximum Input/Output	8 per module
	Multiconnector max. Current	100 mA
	Connections to manifold	Direct connection to 25 poles connector
	Maximum n. of moduls	2
	Protection degree	IP65 when assembled
	Ambient temperature	from -0° to +50° C

CORRESPONDENCE BETWEEN MULTI-POLE SIGNAL AND CONNECTOR

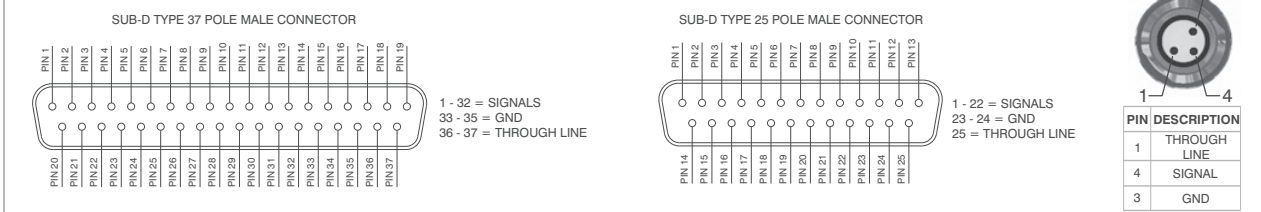

Connection modes:

The I/O module changes its operation depending on the way the manifold is controlled. There are two possible modes:

- A) Control via multi-pole connection
- B) Control via fieldbus

A) Control via multi-pole :

M8 connector used as Input:



Attention: Voltage applied to each connector is passed to multi-pole connector pin.

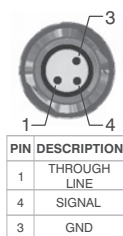

In order to use the I/O module, the correct right hand endplate with 25 pole female outlet connector must be used. (Code 2530.03.25P).



M8 connector used as Output:

Output voltage will be the same as is applied at the multi-pole connector pin. The maximum output current depends upon the power unit used, but we recommend no more than 250mA.



Attention: Since every cable has a degree of resistance, there will always be a voltage drop depending on the cable's length, sectional area and the current.

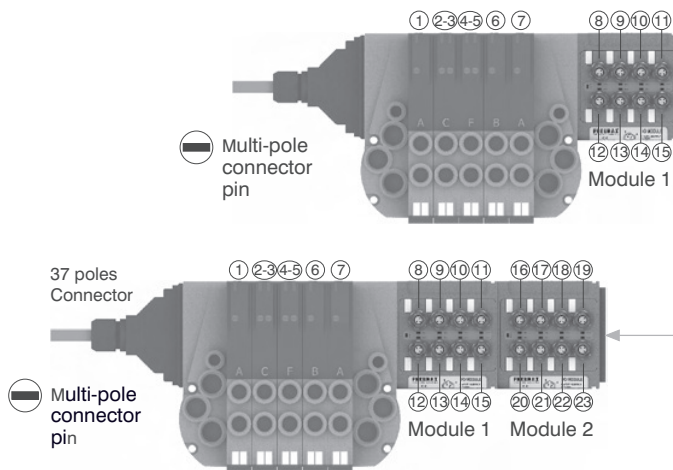

Attention: Only one more I/O module can be added.

Attention: No more additions are possible

Attention : Optyima 32-F solenoid valve manifolds permit up to 22 electrical signals that are not used by manifolds to be made available: these signals can be managed by another manifold and / or by I/O modules. The I/O module will manage these unused signals. Connections that are not managing useful signals will remain unconnected.

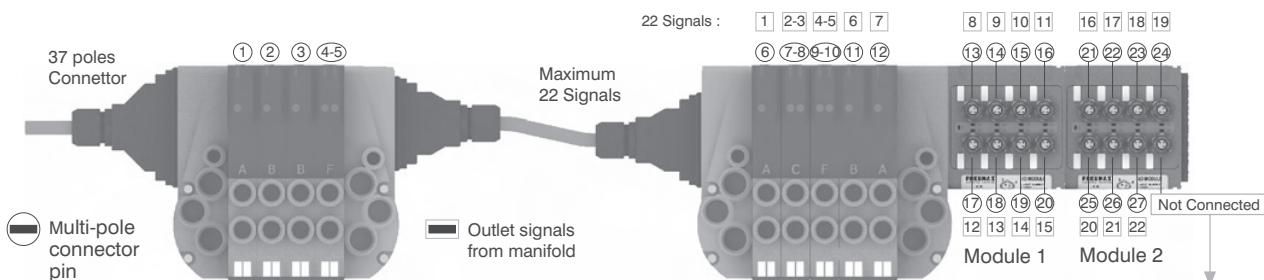

Please note: this example considers a 37 pin multi-pole connector. The same configuration managed by a 25 pin multi-pole connector will stop at number 22 of multi-pole connector and at number 17 of the manifold. 22 17

Attention: Signal Not connected
GND Not connected
Through line Connected



Please note: Optyima 32-F solenoid valve manifolds manage up to 32 signals. If the manifold uses more than 24 signals the I/O module will manage only the remainder. Connections that are not managing useful signals will remain unconnected.

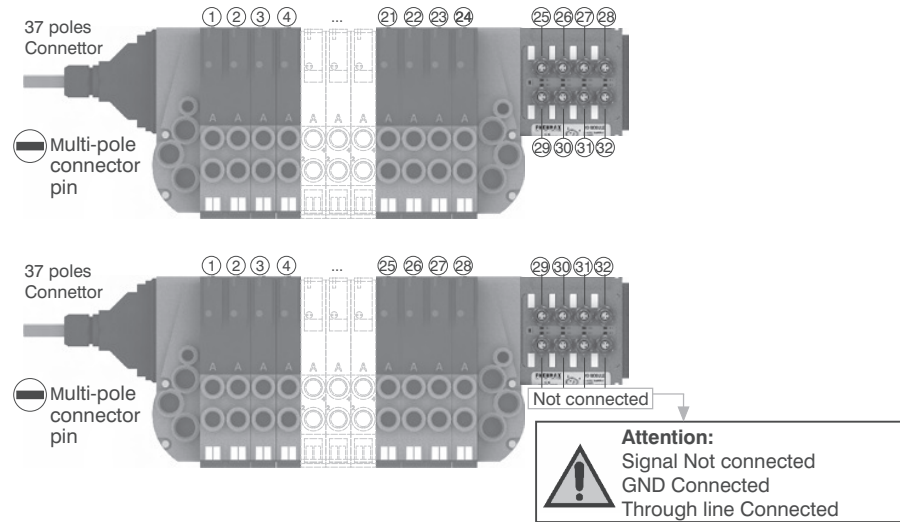

B) Control via fieldbus:

With this kind of control the I/O module can only be used as an output. Pin 1 of each connector is not connected. The output voltage will be 0.7V lower than that applied to Pin 4 of the connector. The maximum output current for each output is 100mA. The correspondence between control byte and each single output depends on how many electrical signals are used by the manifold and by the relative position of the I/O module.

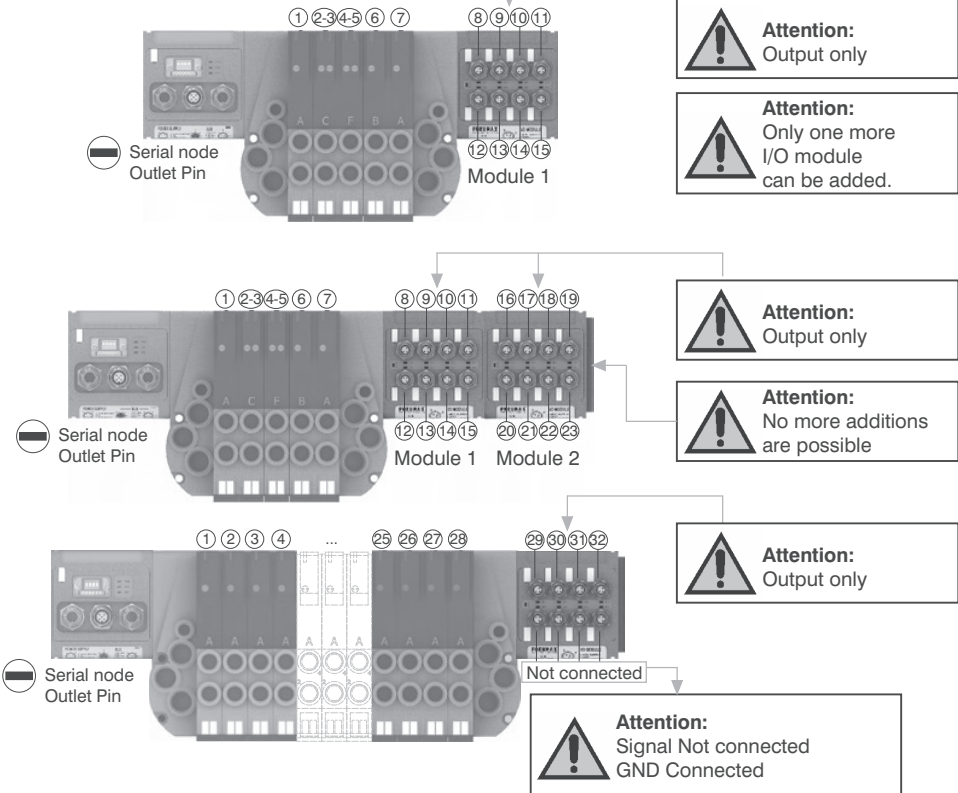
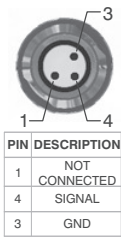

Please note: I/O modules don't allow to connect any additional valves manifold after them.

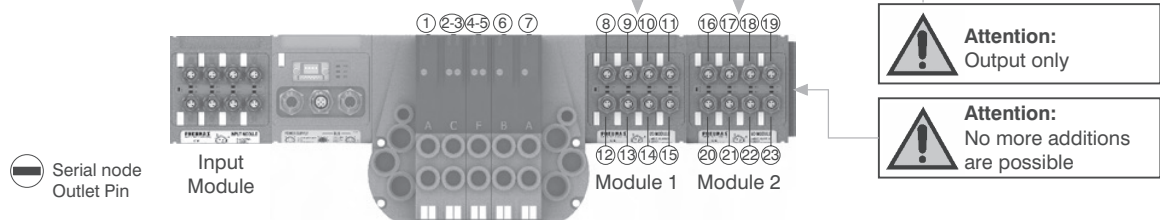

From the top

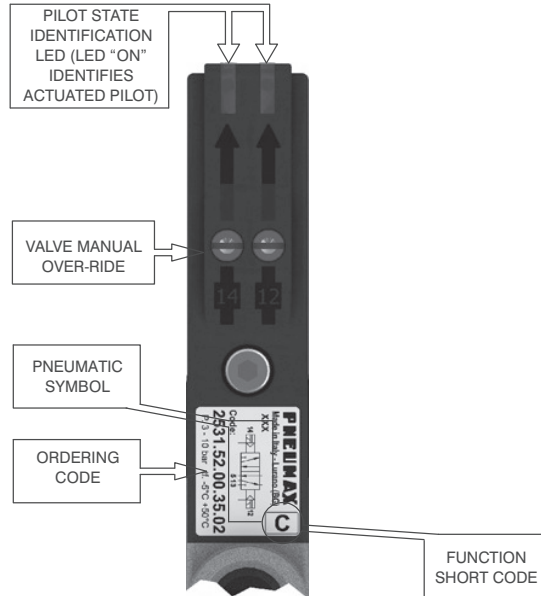
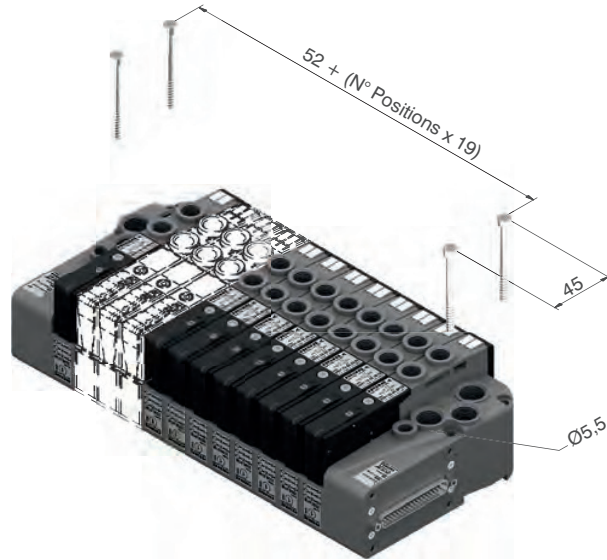

DIN rail fixing

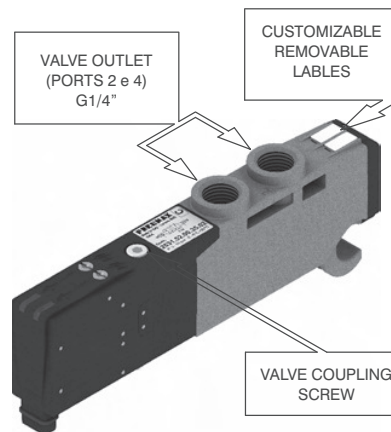
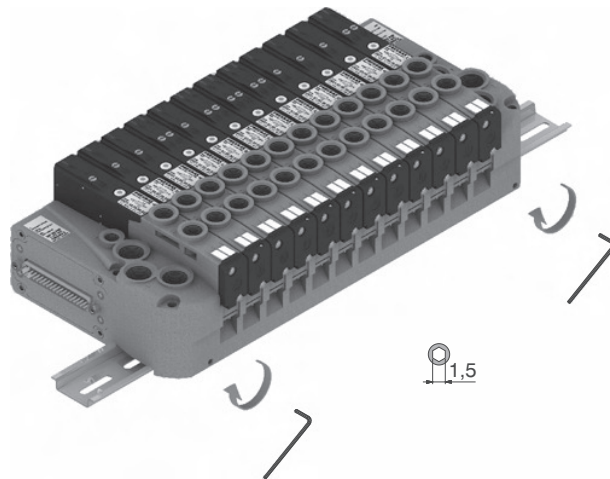

Maximum possible size according to valves seats

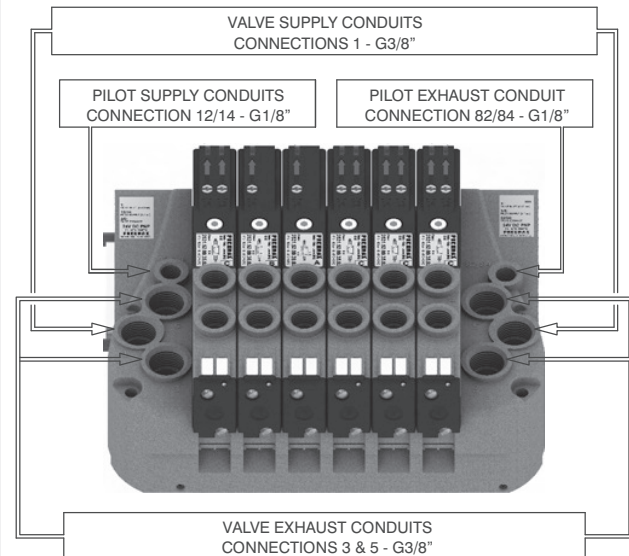
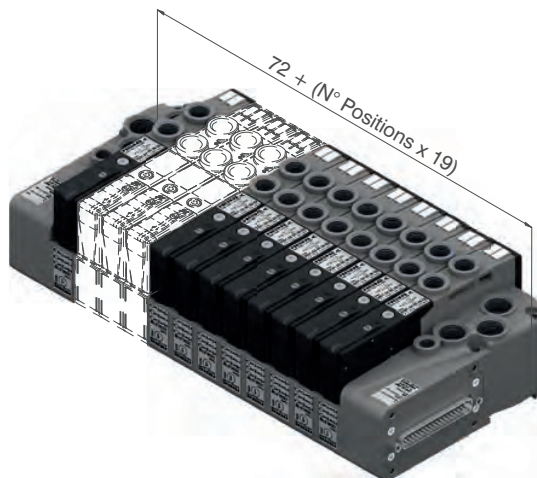

Manual override actuation

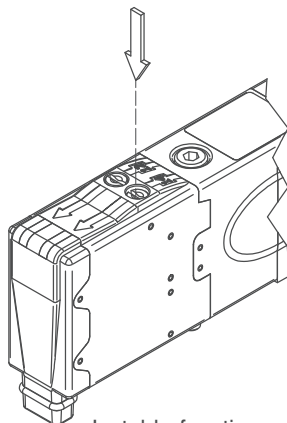
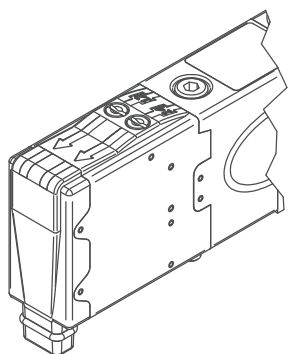

Instable function: push to actuate
(when released it moves back to
the original position).

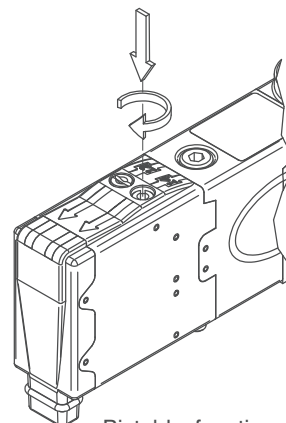

Bistable function: push and
turn to get the bistable
function

NOTE : It is strongly suggested to replace the original position after using

2

Valve Installation

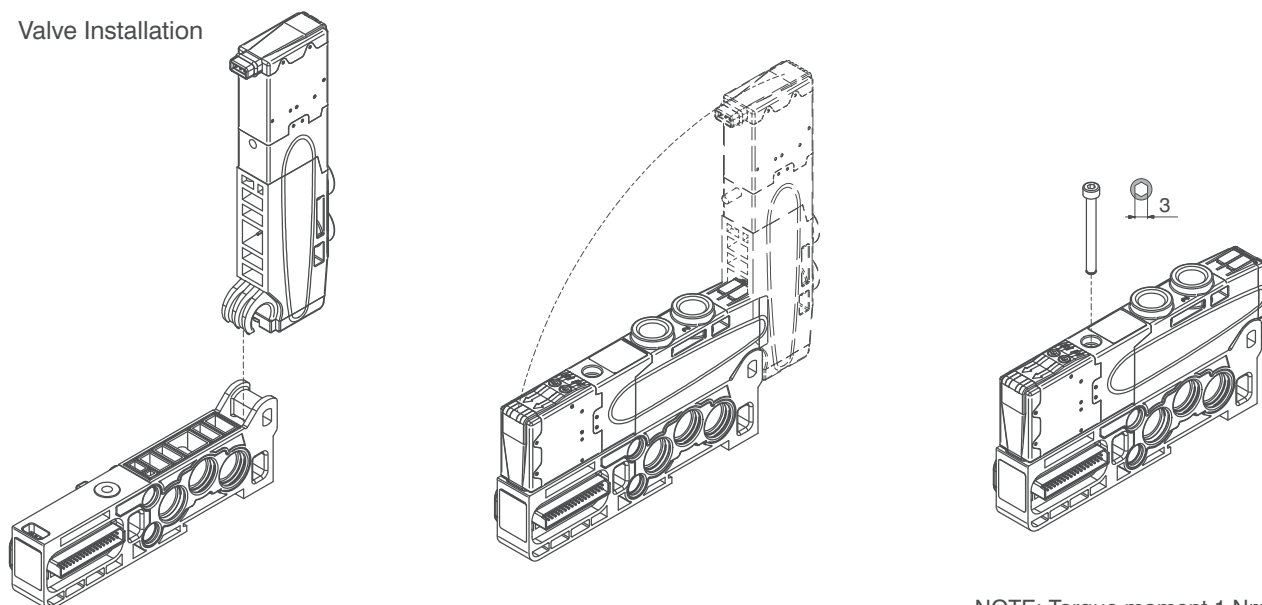

NOTE: Torque moment 1 Nm

Manifold assembly

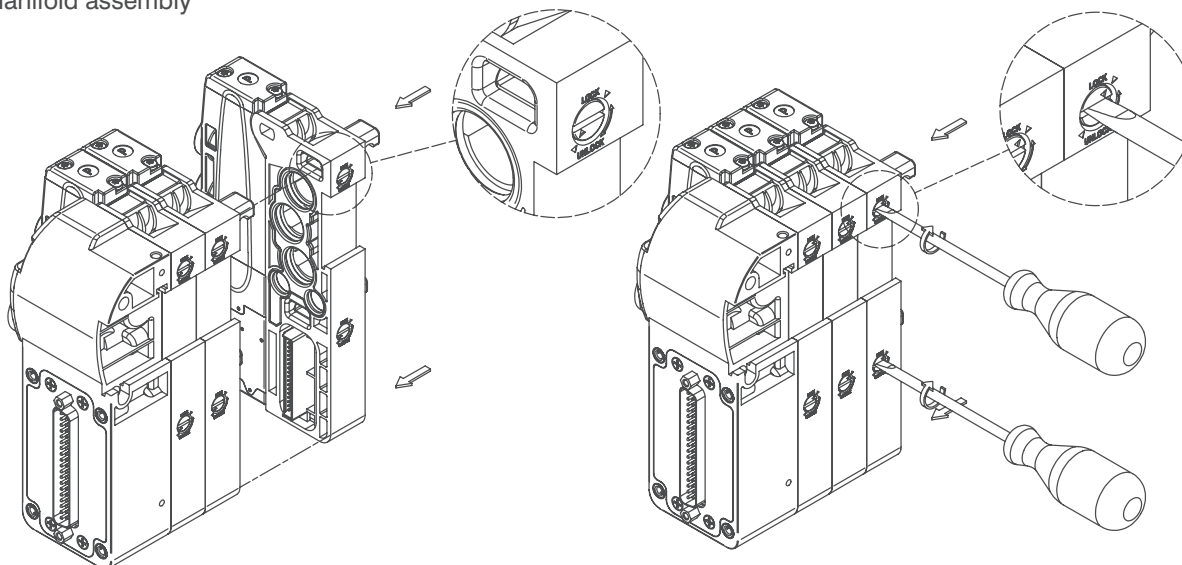

2

Manifold Layout configuration

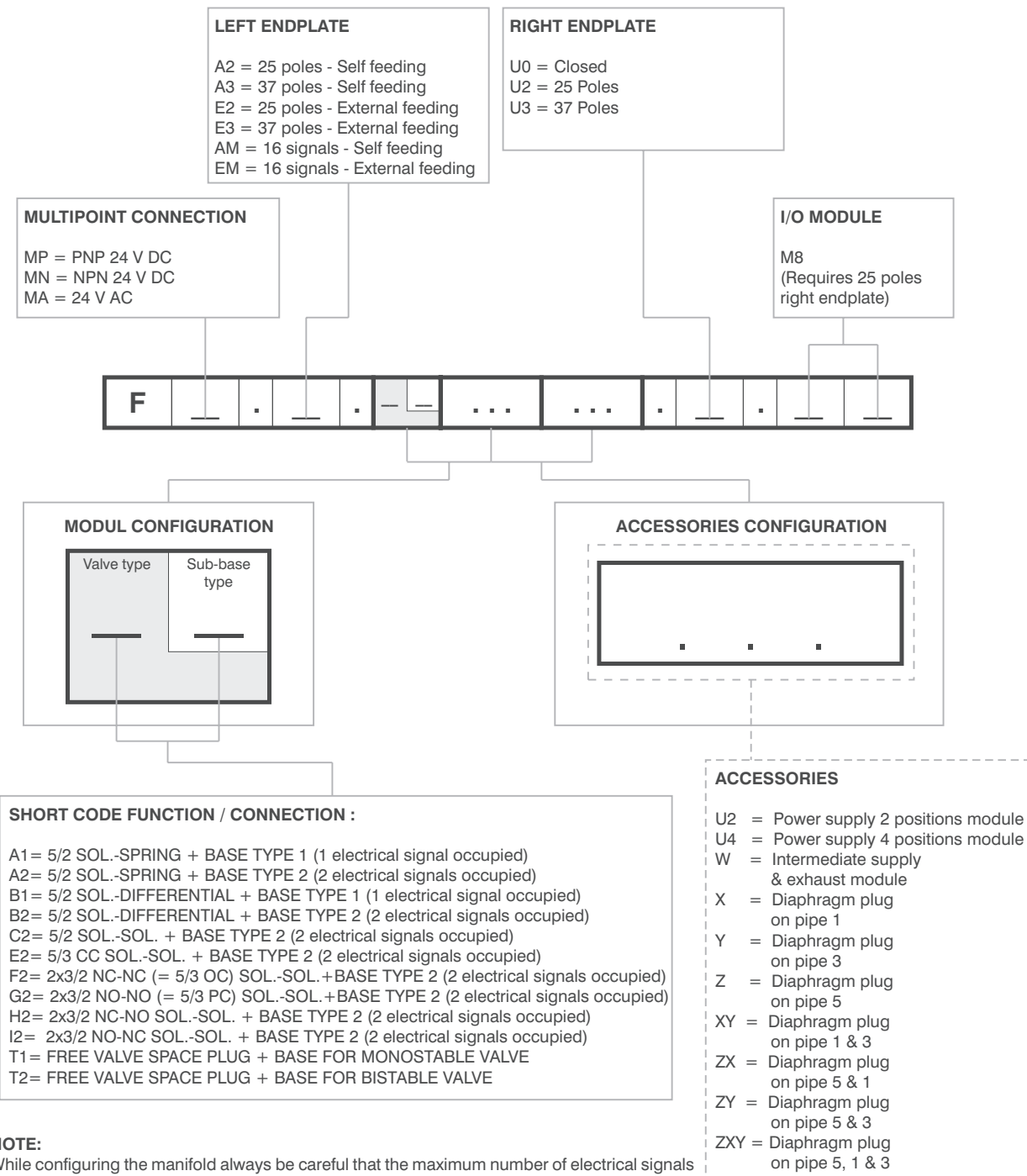

SHORT CODE FUNCTION / CONNECTION :

- A1= 5/2 SOL.-SPRING + BASE TYPE 1 (1 electrical signal occupied)
- A2= 5/2 SOL.-SPRING + BASE TYPE 2 (2 electrical signals occupied)
- B1= 5/2 SOL.-DIFFERENTIAL + BASE TYPE 1 (1 electrical signal occupied)
- B2= 5/2 SOL.-DIFFERENTIAL + BASE TYPE 2 (2 electrical signals occupied)
- C2= 5/2 SOL.-SOL. + BASE TYPE 2 (2 electrical signals occupied)
- E2= 5/3 CC SOL.-SOL. + BASE TYPE 2 (2 electrical signals occupied)
- F2= 2x3/2 NC-NC (= 5/3 OC) SOL.-SOL.+BASE TYPE 2 (2 electrical signals occupied)
- G2= 2x3/2 NO-NO (= 5/3 PC) SOL.-SOL.+BASE TYPE 2 (2 electrical signals occupied)
- H2= 2x3/2 NC-NO SOL.-SOL. + BASE TYPE 2 (2 electrical signals occupied)
- I2= 2x3/2 NO-NC SOL.-SOL. + BASE TYPE 2 (2 electrical signals occupied)
- T1= FREE VALVE SPACE PLUG + BASE FOR MONOSTABLE VALVE
- T2= FREE VALVE SPACE PLUG + BASE FOR BISTABLE VALVE

NOTE:

While configuring the manifold always be careful that the maximum number of electrical signals available is:
 32 when an input 37 poles endplate is used.
 22 when an input 25 poles endplate is used.
 The use of monostable valve mounted on a base type 2 (2 electrical signals occupied) causes the loss of one electric signal.
 In this case the monostable valve can be replaced by a bistable valve. The diaphragms plugs are used to intercept the conduits 1,3 & 5 of the base. If it is necessary to interrupt more than one conduit in the same time then put in line the letters which identifies the position (for example : regarding the 3 & 5 conduits, put the Y & Z letters).
 Should one or more conduits be cut more than one time it is necessary to add the relevant intermediate Supply/Exhaust module.



General:

CANopen® module is directly integrated on Optyma-F solenoid valves manifold via a 37 poles connector, normally used for multipolar cable connection.
 Optyma-F solenoid valves connected to node must be PNP equivalent (final 02 in ordering code).
 The node can be easily installed also on solenoid valves manifold already mounted on equipment.
 Module can manage up to 32 solenoid valves, and, in the same time, a max number of 4 Input modules 5225.08F or a max number of 2 Input modules 5225.25F.
 CANopen® module recognizes automatically the presence of the Input modules on power on.
 Regardless of the number of Input modules connected, the manageable solenoid valves are 32.
 Node power supply is made by a M12 4P male circular connector.
 The separation between node 24 VDC Power supply and outputs 24 VDC allows to switch off the outputs maintaining powered the node and inputs, if present.
 Connection to Bus CANopen® is possible via 2 M12 5P male - female circular connectors; these two are connected in parallel and according to CiA Draft Recommendation 303-1 (V. 1.3 : 30 December 2004).
 Transmission speed can be set by 3 dip-switches.
 The node address can be set by 6 dip-switches using BCD numeration.
 The module includes an internal terminating resistance that can be activated by a dip-switch.

Ordering code

5525.32F



Scheme / Overall dimensions and I/O layout :

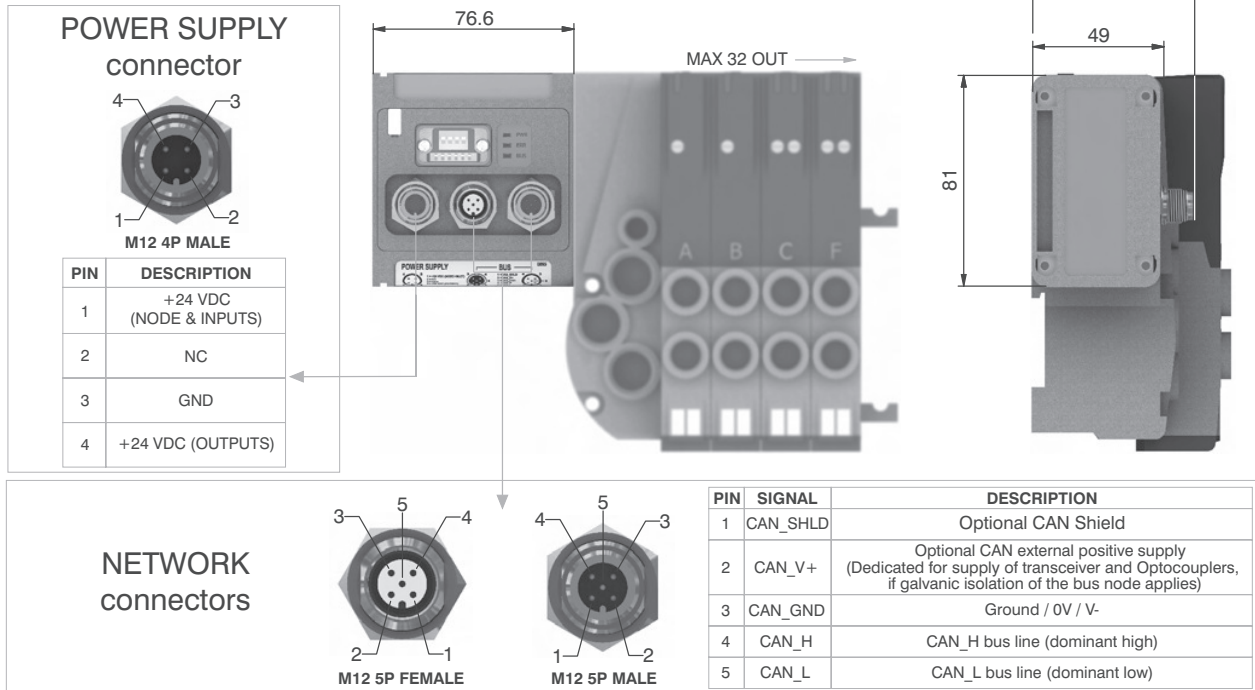

Technical characteristics

	Model	5525.32F
	Specifications	CiA Draft Standard Proposal 301 V 4.10 (15 August 2006)
	Case	Reinforced technopolymer
Power supply	Power supply connection	M12 4P male connector (IEC 60947-5-2)
	Power supply voltage	+24 VDC +/- 10%
	Node consumption (without inputs)	30 mA
	Power supply diagnosis	Green LED PWR
Outputs	PNP equivalent outputs	+24 VDC +/- 10%
	Maximum current for output	100 mA
	Maximum output number	32
	Max output simultaneously actuated	32
Network	Network connectors	2 M12 5P connectors male-female type A (IEC 60947-5-2)
	Baud rate	10 - 20 - 50 - 125 - 250 - 500 - 800 - 1000 Kbit/s
	Addresses, possible numbers	From 1 to 63
	Max nodes in net	64 (slave + master)
	Bus maximum recommended length	100 m at 500 Kbit/s
	Bus diagnosis	Green LED + Red LED
	Configuration file	Available from our web site: http://www.pneumaxspa.com
	IP protection grade	IP65 when assembled
	Temperature range	From 0° to +50° C

General:

DeviceNet module is directly integrated on Optyma-F solenoid valves manifold via a 37 poles connector, normally used for multipolar cable connection.

Optyma-F solenoid valves connected to node must be PNP equivalent (final 02 in ordering code).

The node can be easily installed also on solenoid valves manifold already mounted on equipment.

Module can manage up to 32 solenoid valves, and, in the same time, a max number of 4 Input modules 5225.08F or a max number of 2 Input modules 5225.25F.

DeviceNet module recognizes automatically the presence of the Input modules on power on.

Regardless of the number of Input modules connected, the manageable solenoid valves are 32.

Node power supply is made by a M12 4P male circular connector.

The separation between node 24 VDC Power supply and outputs 24 VDC allows to switch off the outputs maintaining powered the node and inputs, if present.

Connection to Bus DeviceNet is possible via 2 M12 5P male - female circular connectors; these two are connected in parallel and according to DeviceNet Specifications Volume I, release 2.0.

Transmission speed can be set by 3 dip-switches.

The node address can be set by 6 dip-switches using BCD numeration.

The module includes an internal terminating resistance that can be activated by a dip-switch.

Ordering code

5425.32F



Scheme / Overall dimensions and I/O layout :

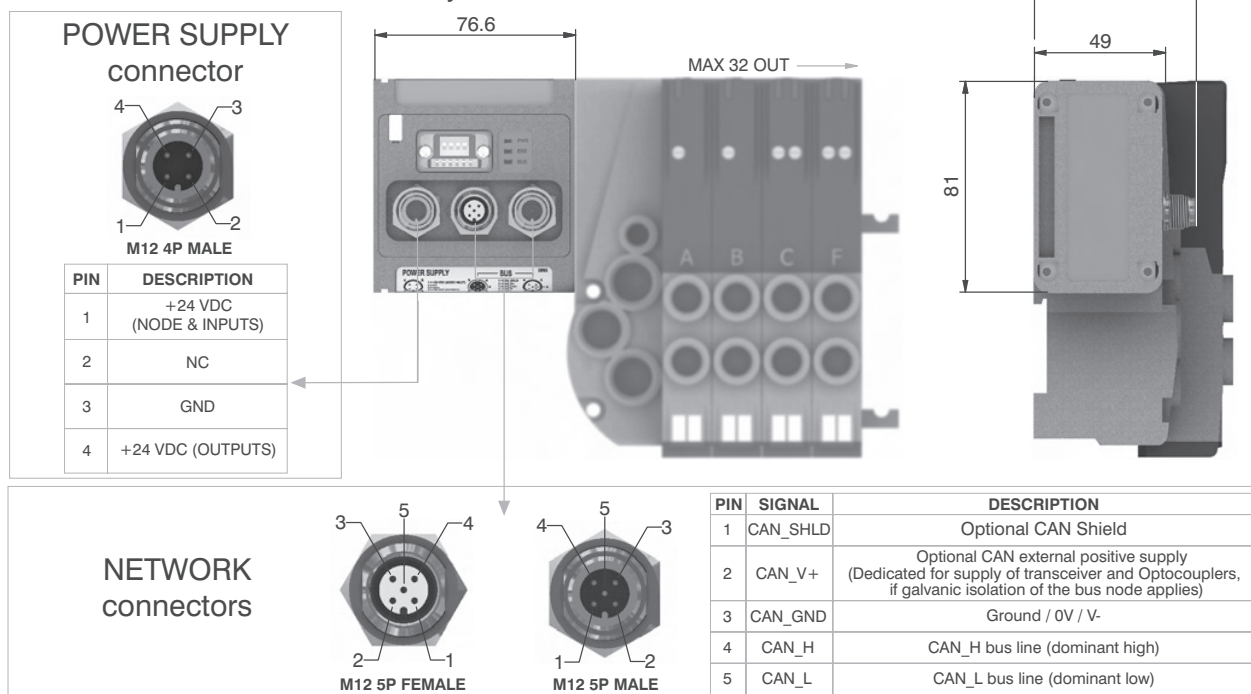

Technical characteristics

Model	5425.32F
Specifications	DeviceNet Specifications Volume I, release 2.0.
Case	Reinforced technopolymer
Power supply	Power supply connection M12 4P male connector (IEC 60947-5-2)
	Power supply voltage +24 VDC +/- 10%
	Node consumption (without inputs) 30 mA
	Power supply diagnosis Green LED PWR
Outputs	PNP equivalent outputs +24 VDC +/- 10%
	Maximum current for output 100 mA
	Maximum output number 32
	Max output simultaneously actuated 32
Network	Network connectors 2 M12 5P connectors male-female type A (IEC 60947-5-2)
	Baud rate 125 - 250 - 500 Kbit/s
	Addresses, possible numbers From 1 to 63
	Max nodes in net 64 (slave + master)
	Bus maximum recommended length 100 m at 500 Kbit/s
	Bus diagnosis Green LED + Red LED
	Configuration file Available from our web site: http://www.pneumaxspa.com
	IP protection grade IP65 when assembled
	Temperature range From 0° to +50° C



General:

PROFIBUS DP module is directly integrated on Optyma-F solenoid valves manifold via a 37 poles connector, normally used for multipolar cable connection.
 Optyma-F solenoid valves connected to node must be PNP equivalent (final 02 in ordering code).
 The node can be easily installed also on solenoid valves manifold already mounted on equipment.
 Module can manage up to 32 solenoid valves, and, in the same time, a max number of 4 Input modules 5225.08F or a max number of 4 Input modules 5225.25F.
 PROFIBUS DP module recognizes automatically the presence of the Input modules on power on.
 Regardless of the number of Input modules connected, the managable solenoid valves are 32.
 Node power supply is made by a M12 4P male circular connector.
 The separation between node 24 VDC Power supply and outputs 24 VDC allows to switch off the outputs maintaining powered the node and inputs, if present.
 Connection to Bus PROFIBUS DP is possible via 2 M12 type B 5P male - female circular connectors; these two are connected in parallel and according to PROFIBUS Interconnection Technology (Version 1.1 : August 2001).
 The node address can be set using BCD numeration: 4 dip-switches for the units and 4 dip-switches for the tens.
 The module includes an internal terminating resistance that can be activated by 2 dip-switches.

Ordering code

5325.32F



Scheme / Overall dimensions and I/O layout :

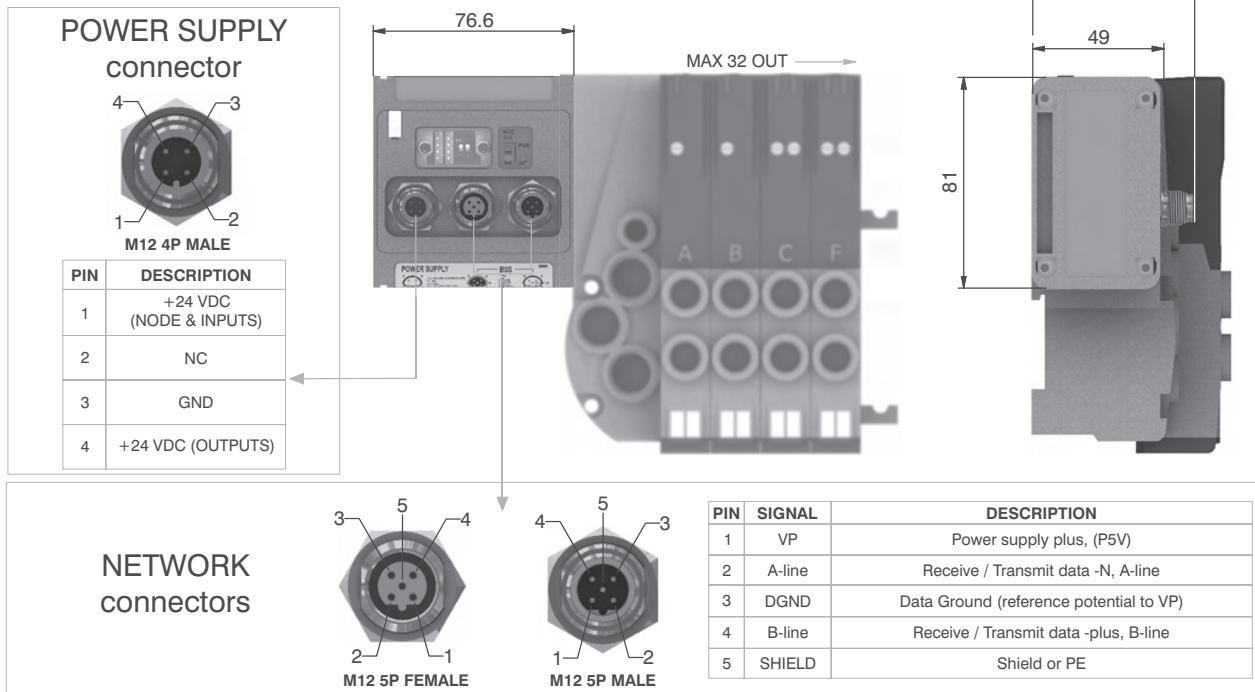

Technical characteristics

	Model	5325.32F
	Specifications	PROFIBUS DP
	Case	Reinforced technopolymer
Power supply	Power supply connection	M12 4P male connector (IEC 60947-5-2)
	Power supply voltage	+24 VDC +/- 10%
	Node consumption (without inputs)	50 mA
	Power supply diagnosis	Green LED PWR / Green LED OUT
Outputs	PNP equivalent outputs	+24 VDC +/- 10%
	Maximum current for output	100 mA
	Maximum output number	32
	Max output simultaneously actuated	32
Network	Network connectors	2 M12 5P male-female connectors type B
	Baud rate	9,6 - 19,2 - 93,75 - 187,5 - 500 - 1500 - 3000 - 6000 - 12000 Kbit/s
	Addresses, possible numbers	From 1 to 99
	Max nodes in net	100 (slave + master)
	Bus maximum recommended length	100 m at 12 Mbit/s - 1200 m at 9,6 Kbit/s
	Bus diagnosis	Green LED + Red LED
	Configuration file	Available from our web site: http://www.pneumaxspa.com
	IP protection grade	IP65 when assembled
	Temperature range	From 0° to +50° C

General:

EtherCAT® module is directly integrated on Optyma-F solenoid valves manifold via a 37 poles connector, normally used for multipolar cable connection.

Optyma-F solenoid valves connected to node must be PNP equivalent (final 02 in ordering code). The node can be easily installed also on solenoid valves manifold already mounted on equipment.

Module can manage up to 32 solenoid valves, and, in the same time, a max number of 4 Input modules 5225.08F or a max number of 2 Input modules 5225.25F.

The EtherCAT® module, regardless the number of Input module connected, reports to have connected 4 Input modules.

Regardless of the number of Input modules connected, the manageable solenoid valves are 32.

Node power supply is made by a M12 4P male circular connector.

The separation between node 24 VDC Power supply and outputs 24 VDC allows to switch off the outputs maintaining powered the node and inputs, if present.

Connection to Bus EtherCAT® is possible via 2 M12 4P type D female circular connectors. These two connectors lead the signal to two different communication ports, so they are not connected in parallel.

The node address is assigned during configuration.

Note: 5700 series has a different configuration file from series 5600.

Ordering code

5725.32F.EC



Scheme / Overall dimensions and I/O layout :

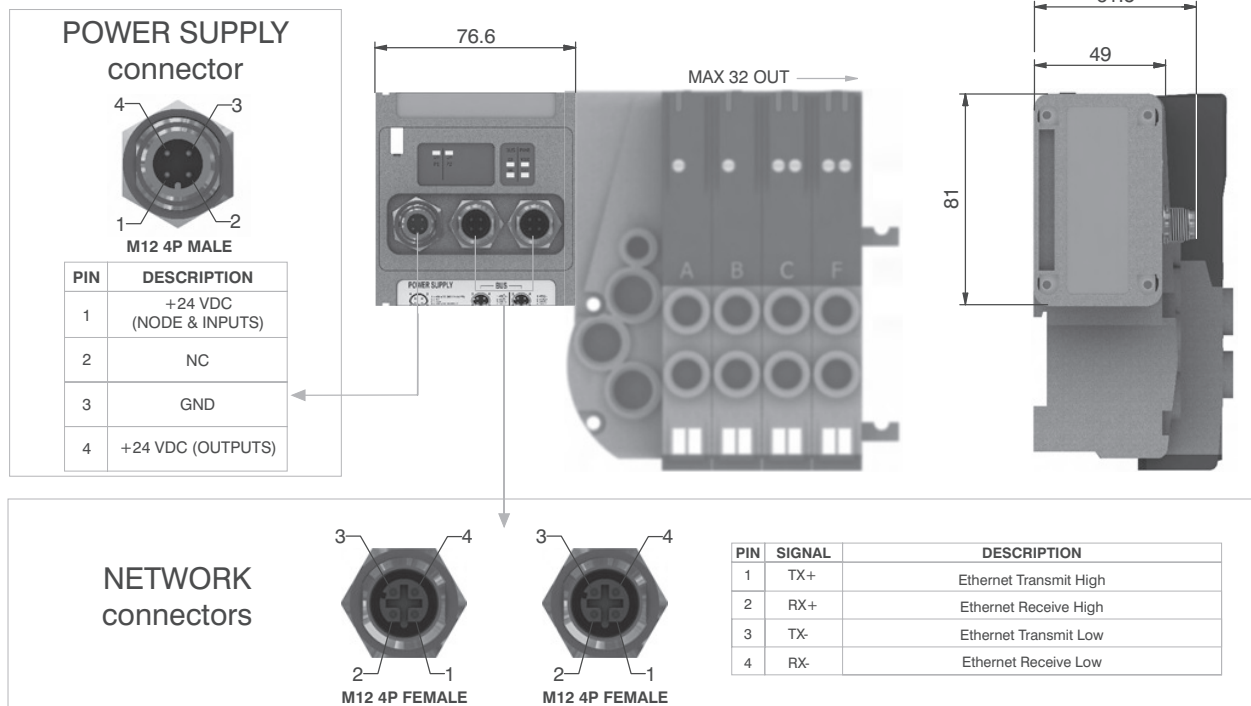

Technical characteristics

	Model	5725.32F.EC
	Specifications	EtherCAT® Specifications ETG.1000 series
	Case	Reinforced technopolymer
Power supply	Power supply connection	M12 4P male connector (IEC 60947-5-2)
	Power supply voltage	+24 VDC +/- 10%
	Node consumption (without inputs)	400 mA
	Power supply diagnosis	Green LED PWR / Green LED OUT
Outputs	PNP equivalent outputs	+24 VDC +/- 10%
	Maximum current for output	100 mA
	Maximum output number	32
	Max output simultaneously actuated	32
Network	Network connectors	2 M12 4P female connectors type D (IEC 61076-2-101)
	Baud rate	100 Mbit/s
	Addresses, possible numbers	From 1 to 65535
	Max nodes in net	65536 (slave + master)
	Maximum distance between 2 nodes	100 m
	Bus diagnosis	1 green and 1 red LED for status + 2 LEDs for link & activity
	Configuration file	Available from our web site: http://www.pneumaxspa.com
	IP protection grade	IP65 when assembled
	Temperature range	From 0° to +50° C



General:

PROFINET IO RT/IRT module is directly integrated on Optyma-F solenoid valves manifold via a 37 poles connector, normally used for multipolar cable connection.
 Optyma-F solenoid valves connected to node must be PNP equivalent (final 02 in ordering code).
 The node can be easily installed also on solenoid valves manifold already mounted on equipment.
 Module can manage up to 32 solenoid valves, and, in the same time, a max number of 4 Input modules 5225.08F or a max number of 4 Input modules 5225.25F.
 The PROFINET IO RT/IRT module, regardless the number of Input module connected, reports to have connected 8 Input modules.
 Regardless of the number of Input modules connected, the managable solenoid valves are 32.
 Node power supply is made by a M12 4P male circular connector.
 The separation between node 24 VDC Power supply and outputs 24 VDC allows to switch off the outputs maintaining powered the node and inputs, if present.
 Connection to Bus PROFINET IO RT/IRT is possible via 2 M12 4P type D female circular connectors. These two connectors lead the signal to two different communication ports, so they are not connected in parallel.
 The node address is assigned during configuration.

Ordering code

5725.32F.PN



Scheme / Overall dimensions and I/O layout :

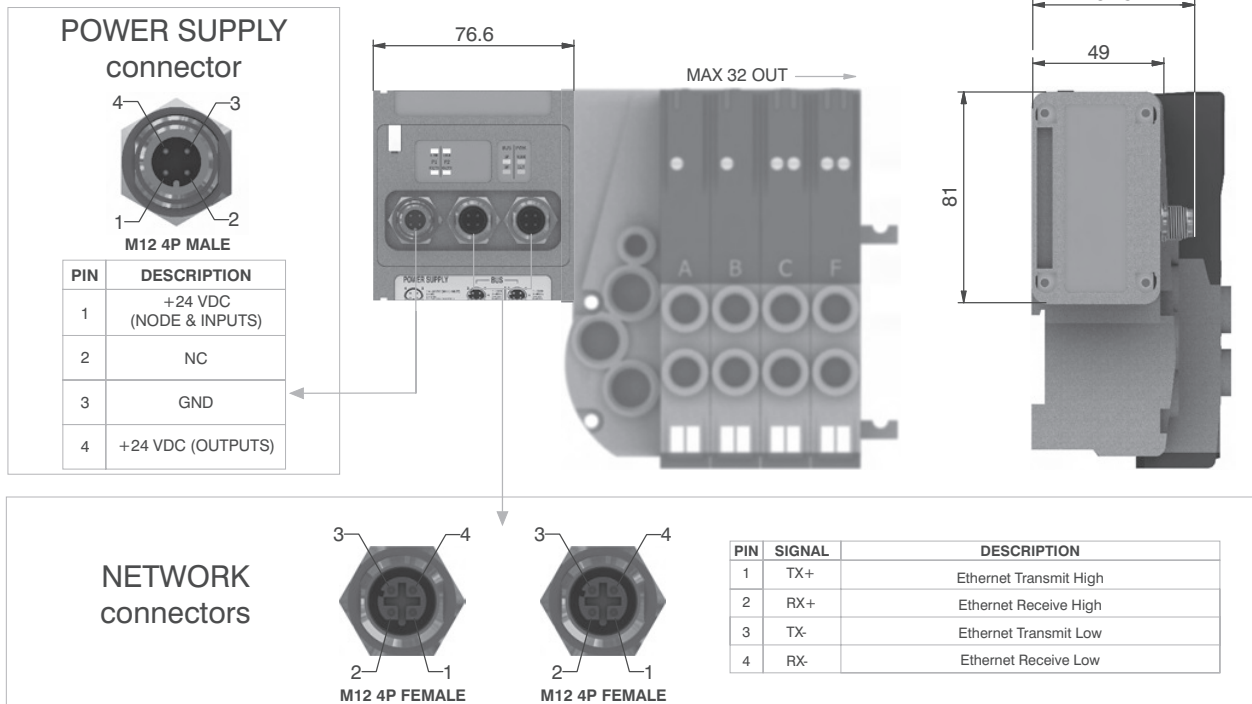

Technical characteristics

	Model	5725.32F.PN
	Specifications	PROFINET IO RT/IRT
	Case	Reinforced technopolymer
Power supply	Power supply connection	M12 4P male connector (IEC 60947-5-2)
	Power supply voltage	+24 VDC +/- 10%
	Node consumption (without inputs)	400 mA
	Power supply diagnosis	Green LED PWR / Green LED OUT
Outputs	PNP equivalent outputs	+24 VDC +/- 10%
	Maximum current for output	100 mA
	Maximum output number	32
	Max output simultaneously actuated	32
Network	Network connectors	2 M12 4P female connectors type D (IEC 61076-2-101)
	Baud rate	100 Mbit/s
	Addresses, possible numbers	As an IP address
	Max nodes in net	As an Ethernet Network
	Maximum distance between 2 nodes	100 m
	Bus diagnosis	1 green and 1 red LED for status + 4 LEDs for link & activity
	Configuration file	Available from our web site: http://www.pneumaxspa.com
	IP protection grade	IP65 when assembled
	Temperature range	From 0° to +50° C

General:

EtherNet/IP module is directly integrated on Optyma-F solenoid valves manifold via a 37 poles connector, normally used for multipolar cable connection.

Optyma-F solenoid valves connected to node must be PNP equivalent (final 02 in ordering code).

The node can be easily installed also on solenoid valves manifold already mounted on equipment.

Module can manage up to 32 solenoid valves, and, in the same time, a max number of 4 Input modules 5225.08F or a max number of 4 Input modules 5225.25F.

The EtherNet/IP module, regardless the number of Input module connected, reports to have connected 8 Input modules.

Regardless of the number of Input modules connected, the manageable solenoid valves are 32.

Node power supply is made by a M12 4P male circular connector.

The separation between node 24 VDC Power supply and outputs 24 VDC allows to switch off the outputs maintaining powered the node and inputs, if present.

Connection to Bus EtherNet/IP is possible via 2 M12 4P type D female circular connectors. These two connectors lead the signal to two different communication ports, so they are not connected in parallel.

The node address is assigned during configuration.

Ordering code

5725.32F.EI



Scheme / Overall dimensions and I/O layout :

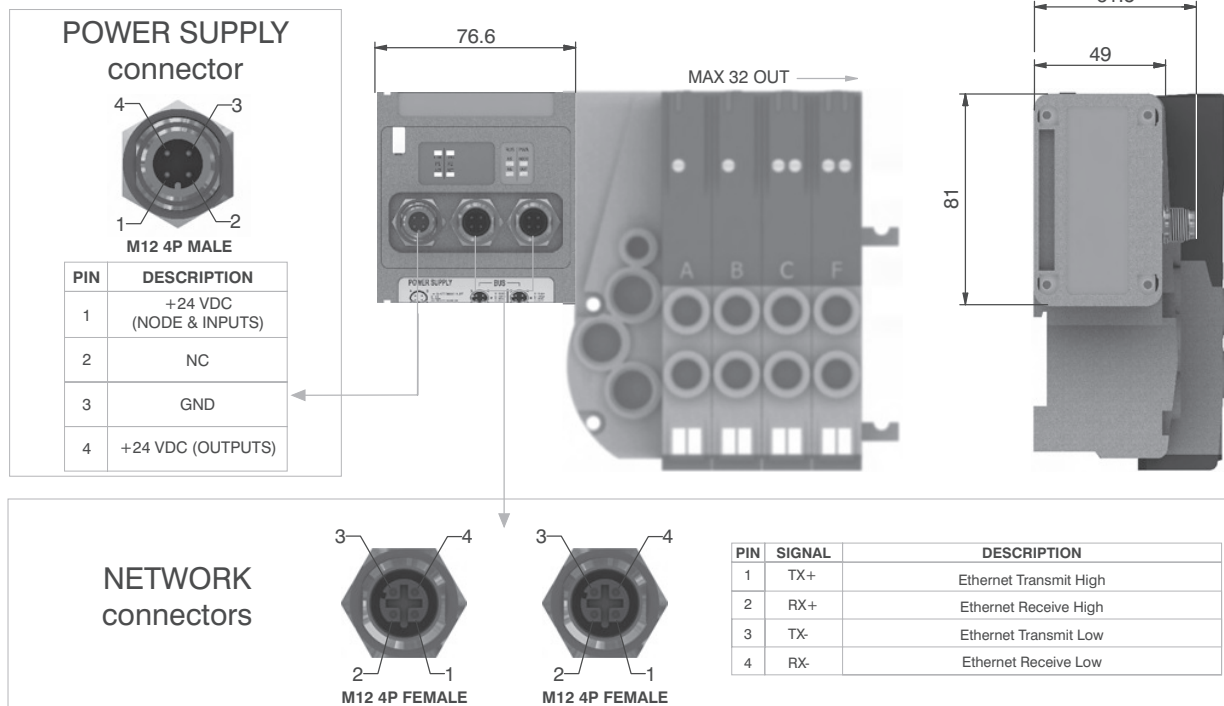

Technical characteristics

Model	5725.32F.EI
Specifications	The EtherNet/IP Specification
Case	Reinforced technopolymer
Power supply	Power supply connection M12 4P male connector (IEC 60947-5-2)
	Power supply voltage +24 VDC +/- 10%
	Node consumption (without inputs) 400 mA
	Power supply diagnosis Green LED PWR / Green LED OUT
Outputs	PNP equivalent outputs +24 VDC +/- 10%
	Maximum current for output 100 mA
	Maximum output number 32
	Max output simultaneously actuated 32
Network	Network connectors 2 M12 4P female connectors type D (IEC 61076-2-101)
	Baud rate 100 Mbit/s
	Addresses, possible numbers As an IP address
	Max nodes in net As an Ethernet Network
	Maximum distance between 2 nodes 100 m
	Bus diagnosis 1 green and 1 red LED for status + 4 LEDs for link & activity
	Configuration file Available from our web site: http://www.pneumaxspa.com
	IP protection grade IP65 when assembled
	Temperature range From 0° to +50° C



General:

Powerlink module is directly integrated on Optyma-F solenoid valves manifold via a 37 poles connector, normally used for multipolar cable connection.
Optyma-F solenoid valves connected to node must be PNP equivalent (final 02 in ordering code).

The node can be easily installed also on solenoid valves manifold already mounted on equipment.

Module can manage up to 32 solenoid valves, and, in the same time, a max number of 4 Input modules 5225.08F or a max number of 4 Input modules 5225.25F.

The Powerlink module, regardless the number of Input module connected, reports to have connected 8 Input modules.

Regardless of the number of Input modules connected, the managable solenoid valves are 32.

Node power supply is made by a M12 4P male circular connector.

The separation between node 24 VDC Power supply and outputs 24 VDC allows to switch off the outputs maintaining powered the node and inputs, if present.

Connection to Bus Powerlink is possible via 2 M12 4P type D female circular connectors. These two connectors lead the signal to two different communication ports, so they are not connected in parallel.

The node address is assigned during configuration.

Ordering code

5725.32F.PL



Scheme / Overall dimensions and I/O layout :

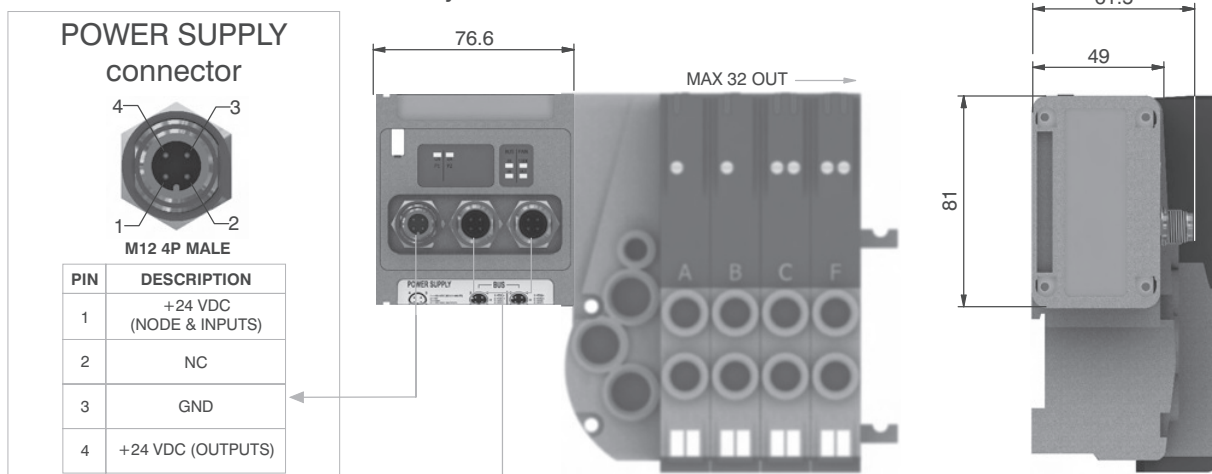

POWER SUPPLY connector

M12 4P MALE

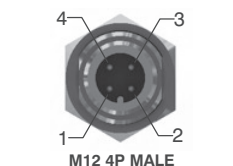

PIN	DESCRIPTION
1	+24 VDC (NODE & INPUTS)
2	NC
3	GND
4	+24 VDC (OUTPUTS)

NETWORK connectors

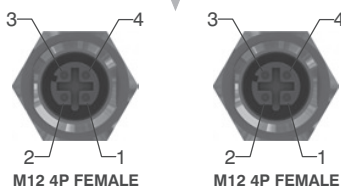

PIN	SIGNAL	DESCRIPTION
1	TX+	Ethernet Transmit High
2	RX+	Ethernet Receive High
3	TX-	Ethernet Transmit Low
4	RX-	Ethernet Receive Low

Technical characteristics

	Model	5725.32F.PL
	Specifications	Ethernet POWERLINK Communication Profile Specifications
	Case	Reinforced technopolymer
Power supply	Power supply connection	M12 4P male connector (IEC 60947-5-2)
	Power supply voltage	+24 VDC +/- 10%
	Node consumption (without inputs)	400 mA
	Power supply diagnosis	Green LED PWR / Green LED OUT
Outputs	PNP equivalent outputs	+24 VDC +/- 10%
	Maximum current for output	100 mA
	Maximum output number	32
	Max output simultaneously actuated	32
Network	Network connectors	2 M12 4P female connectors type D (IEC 61076-2-101)
	Baud rate	100 Mbit/s
	Addresses, possible numbers	239
	Max nodes in net	240
	Maximum distance between 2 nodes	100 m
	Bus diagnosis	1 green and 1 red LED for status + 2 LEDs for link & activity
	Configuration file	Available from our web site: http://www.pneumaxspa.com
	IP protection grade	IP65 when assembled
	Temperature range	From 0° to +50° C



General:

Modules have 8 connectors M8 3P female.

The Inputs are PNP equivalent 24 VDC ±10%.

To each connector it is possible to plug both 2 wires Inputs (switches, magnetic switches pressure switches, etc.) or 3 wires Inputs (proximity, photocells, electronic sensors, etc).

The maximum current available for all 8 Inputs is 200 mA.

Each module includes a 200 mA self-mending fuse. If a short circuit or a overcharge (overall current >200mA) occur the safety device acts cutting the 24 VDC power supply to all M8 connectors on the module and switching off the green LED PWR. Any other Input module connected to the node will remain powered and will function correctly.

Once the cause of the fault disappears the green LED PWR lights up indicating the ON state and the node will re-start to operate.

The maximum number of Input modules supported is 4.

Ordering code

5225.08F

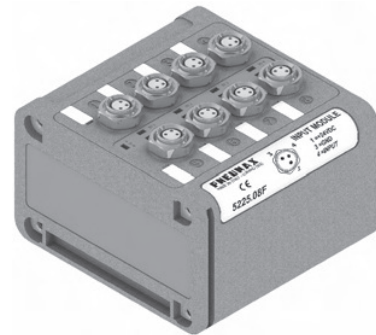

2

Scheme / Overall dimensions and I/O layout :

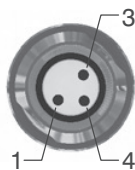
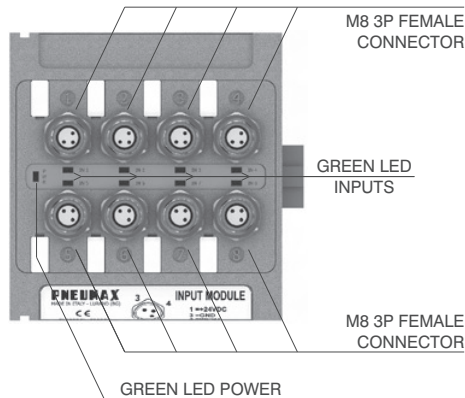

PIN	DESCRIPTION
1	+24 VDC
4	INPUT
3	GND

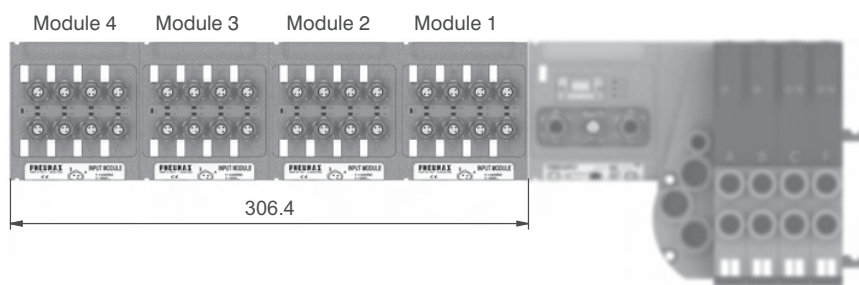
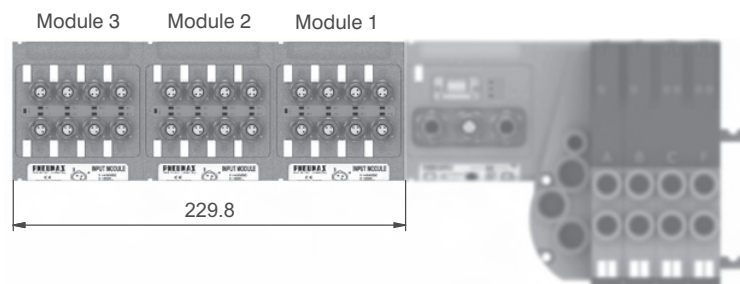
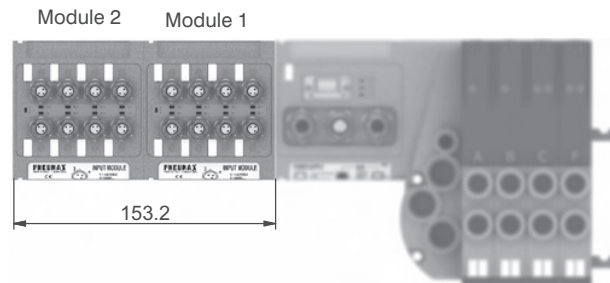
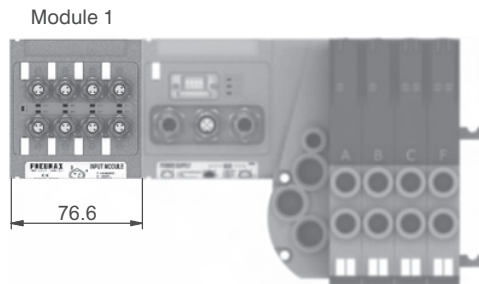



General :

Modules are fitted with SUB-D 25 pin female connector.

The Inputs are PNP equivalent 24VDC ±10%.

To the connector it is possible to connect both 2 wires Inputs (switches, magnetic switches pressure switches etc.) or 3 wires (proximity, photocells, electronic end of stroke sensors etc).

The maximum current available for all 16 Inputs is 750 mA.

Each module includes a 750 mA self-mending fuse. Should a short circuit or a overcharge (overall current >750mA) occur the safety device intervenes cutting the 24VDC power supply to all pins and switching off the green LED PWR. Any other Input module connected to the node will remain powered and will function correctly.

Once the cause of the fault is removed the green LED lights up indicating the ON state and the node will re-start to operate. This 16 Inputs module is counted as two 8 Inputs modules.

The Maximum number of 16 Inputs modules supported is 2 for CANopen®, DeviceNet and EtherCAT®.

The Maximum number of 16 Inputs modules supported is 4 for PROFIBUS DP, PROFINET IO RT/IRT, EtherNet/IP and Powerlink.

Ordering code

5225.25F



Scheme / Overall dimensions and I/O layout :

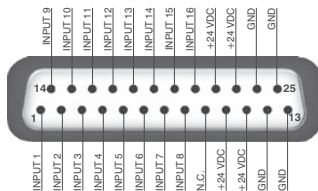
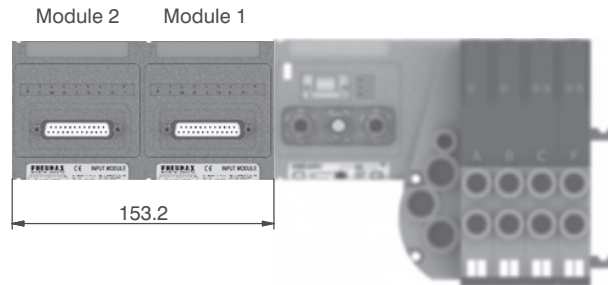
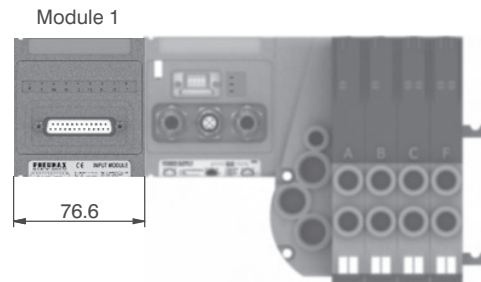
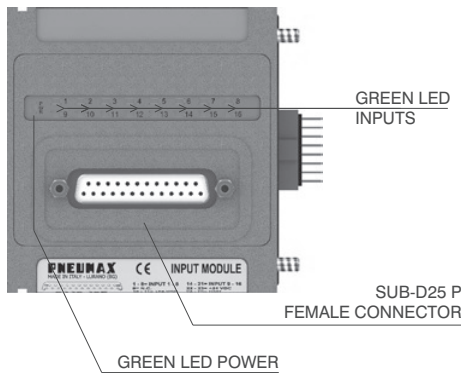



2

General :

This module is fitted with two M8 3 pin female connectors.

With this module is possible to read two analogue inputs (voltage or current).

The inputs are sampled at 12 bit.

For practicality the sampled value is transmitted with 16 bit, of which the four less significant are fixed at zero.

Available models:

5225.2T.00F (voltage signal 0 - 10V);

5225.2T.01F (voltage signal 0 - 5V);

5225.2C.00F (current signal 4 - 20mA);

5225.2C.01F (current signal 0 - 20mA).

Each module includes a 300 mA self-mending fuse. Should a short circuit or a overcharge (overall current >300mA) occur the safety device intervenes cutting the 24VDC power supply to all M8 connectors on the module and switching off the green LED. Any other Input module connected to the node will remain powered and will function correctly.

Once the cause of the fault is removed the green LED lights up indicating the ON state and the node will re-start to operate.

This module is counted as four 8 digital Inputs modules.

The Maximum number of 2 analogue Inputs modules supported is 1 for CANopen®, DeviceNet, PROFIBUS DP and EtherCAT®.

The Maximum number of 2 analogue Inputs modules supported is 2 for PROFINET IO RT/IRT, EtherNet/IP and Powerlink.

Scheme / Overall dimensions and I/O layout :

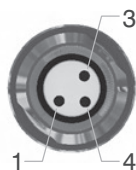
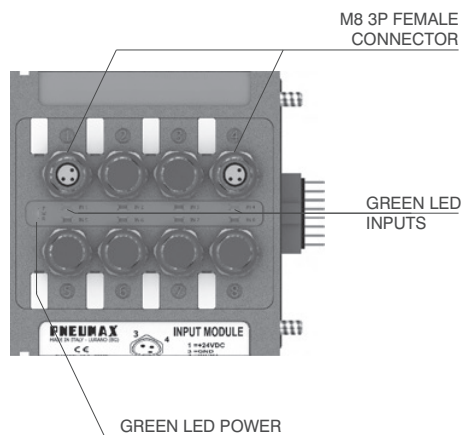

PIN	DESCRIPTION
1	+24 VDC
4	INPUT
3	GND

Ordering code

5225.2 _ . _ _ F



Module 1

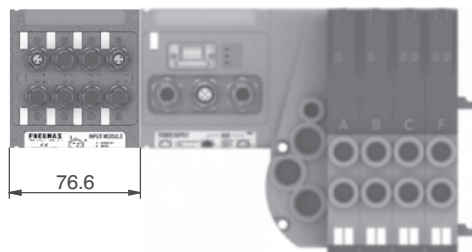

Module 2 Module 1

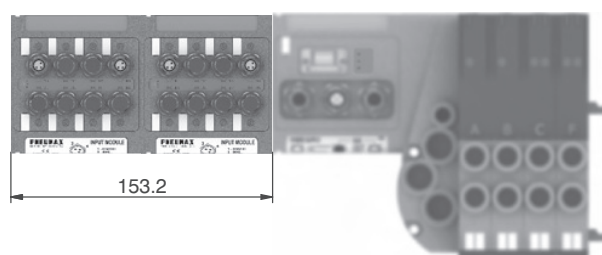



2

M12A 4P female Socket

Ordering code
5312A.F04.00

Power supply straight connector.



Upper view Slave connector

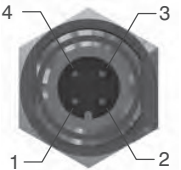

PIN	DESCRIPTION
1	+24 VDC Node
2	
3	0 V
4	+24 VDC Output

M8 3P male Plug

Ordering code
5308A.M03.00

Input straight connector.



Upper view Slave connector

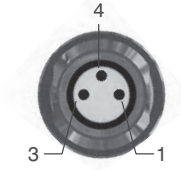

PIN	DESCRIPTION
1	+24 VDC
4	INPUT
3	GND

M12A 5P female Socket

Ordering code
5312A.F05.00

Network straight connector: for Bus CANOpen®, DeviceNet.



Upper view Slave connector

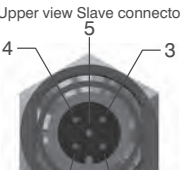

PIN	DESCRIPTION
1	(CAN_SHIELD)
2	(CAN_V+)
3	CAN_GND
4	CAN_H
5	CAN_L

M12A 5P male Plug

Ordering code
5312A.M05.00

Network straight connector: for BUS CANOpen®, DeviceNet.



Upper view Slave connector

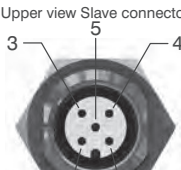

PIN	DESCRIPTION
1	(CAN_SHIELD)
2	(CAN_V+)
3	CAN_GND
4	CAN_H
5	CAN_L

M12B 5P female Plug

Ordering code
5312B.F05.00

Network straight connector: for Bus PROFIBUS DP.



Upper view Slave connector

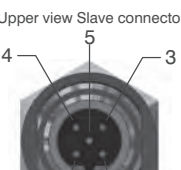

PIN	DESCRIPTION
1	Power Supply
2	A-line
3	DGND
4	B-line
5	SHIELD

M12B 5P male Plug

Ordering code
5312B.M05.00

Network straight connector: for Bus PROFIBUS DP.



Upper view Slave connector

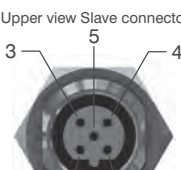

PIN	DESCRIPTION
1	Power Supply
2	A-line
3	DGND
4	B-line
5	SHIELD

M12D 4P male Plug

Ordering code
5312D.M04.00

Network straight connector: for EtherCAT®, PROFINET IO RT/IRT, EtherNet/IP and Powerlink.



Upper view Slave connector

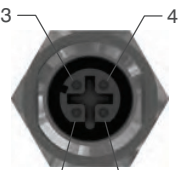

PIN	SIGNAL	DESCRIPTION
1	TX+	Ethernet Transmit High
2	RX+	Ethernet Receive High
3	TX-	Ethernet Transmit Low
4	RX-	Ethernet Receive Low

M12 Plug

Ordering code
5300.T12



M8 Plug

Ordering code
5300.T08



Trademarks: EtherCAT® is registered trademark and patented technology, licensed by Beckhoff Automation GmbH, Germany.